

COOLING TOWER FILTER SYSTEM INSTALLATION & GUIDE

FOR USE WITH PREVENT MODEL BHA EQUIPMENT PROTECTION FILTER

PARTS LIST

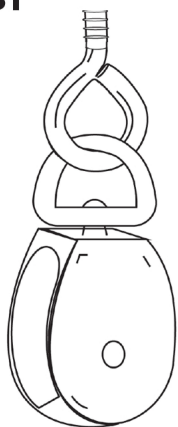

(2) 2" Single Eye Pulleys with Eye Bolt

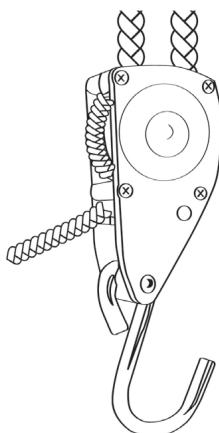

(2) Rope Ratchets with Hooks

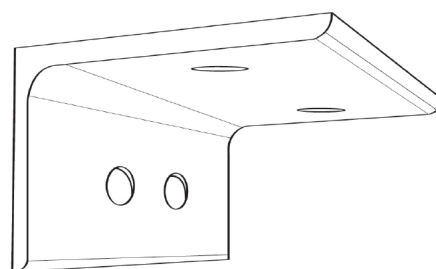

(4) Predrilled Corner Brackets

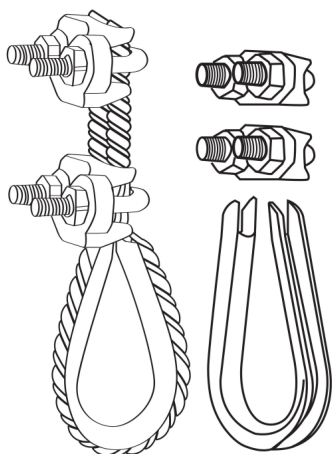

(6) Clamp Sets for Wire
Rope Top and Bottom

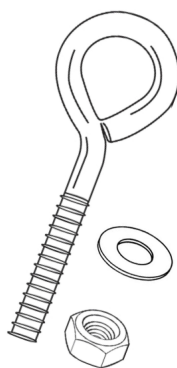

(6) Eye Bolts, (16) Hex Nuts,
(16) Washers



(2) 3/8" x 50'
Poly Braid Rope



(1) 1/8" x 12'
Wire Rope

(2) 1/8" x 20'
Wire Rope



(Same amount as grommets)
1 1/2" Carabiner Clips for Wire Rope
Side Guides



(8) 1/4 - 14 x 1"
Sheet Metal Screws

REQUIRED PART NOT INCLUDED:

1 inch Metal Pipe Galvanized Cut-to-Size

Where to purchase:

Home Depot: SKU 580015

PREVENT CTFS INSTRUCTIONS

Top and Bottom Bracket Installation

Parts: (4) Predrilled Corner Brackets; (8) Sheet Metal Screws | Tools: Portable Drill

Note: Must know the measurement of PreVent filter screen before installation. Assemble top brackets 5-6 inches higher than that of the filter screen (this may vary depending on the unit).

Assembly:

- Drill one bracket at each corner with short side against the unit at a width to match your PreVent filter screen.
- Top bracket must be installed 5-6 inches higher than the filter screen.
- Drill bottom bracket to the edge of the unit on both sides.

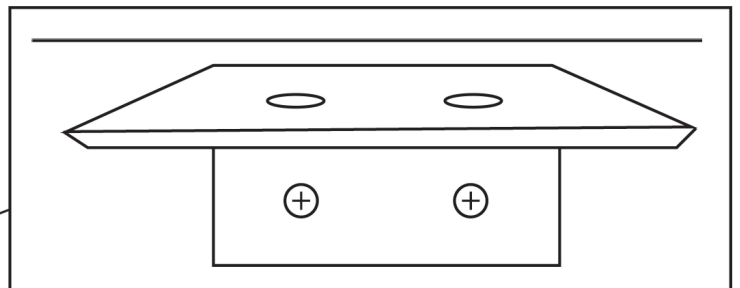
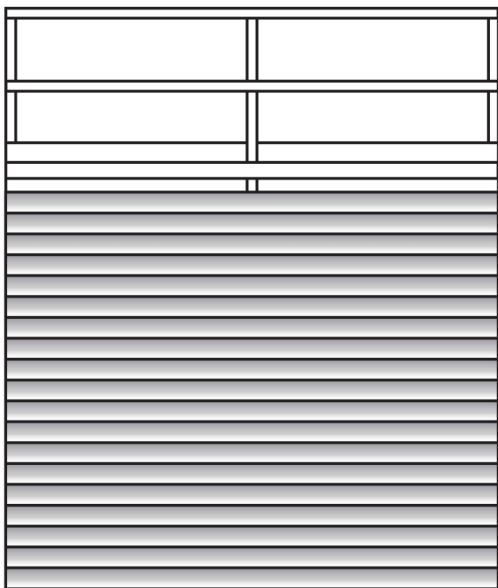
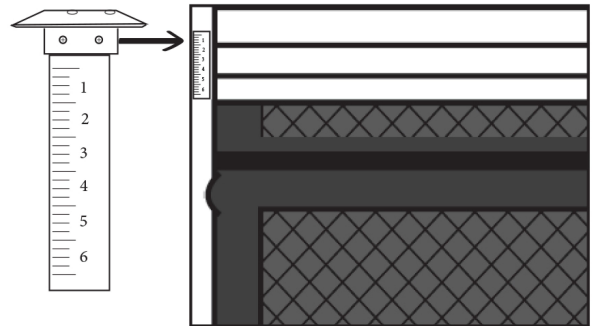
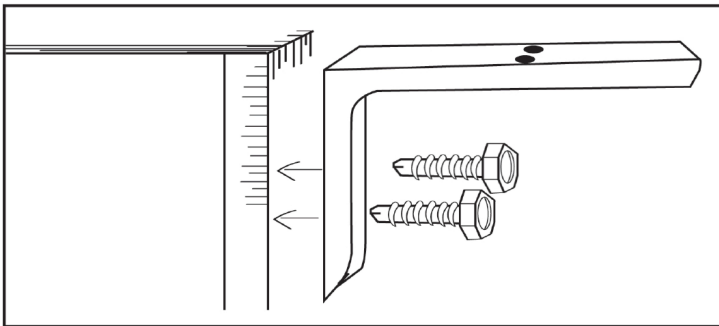

PREVENT CTFS INSTRUCTIONS

Eye Bolt and Wire Guide Rope Installation

Parts: (2) Wire Rope Spools; (2) Clamp Sets for Wire Rope - Top and Bottom; (2) Eye Bolts; (4) Hex Nuts; (4) Washers

Note: Measure and cut the spool of wire rope to the appropriate length between your installed top and bottom brackets.

Assembly:

- Top installation: Attach eye bolts head down to the outside of the top bracket and remain fixed. Use hex nuts and washers above and below bracket for stability.
- Bottom installation: Attach matching eye bolts head up into the outside and inside holes on the bottom bracket. Use hex nuts and washers above and below bracket for stability.
- Loop one end of the wire holder through the outside eye bolt and then feed the wire rope through and attach the clamp set to hold when you have firm tension on the wire rope.

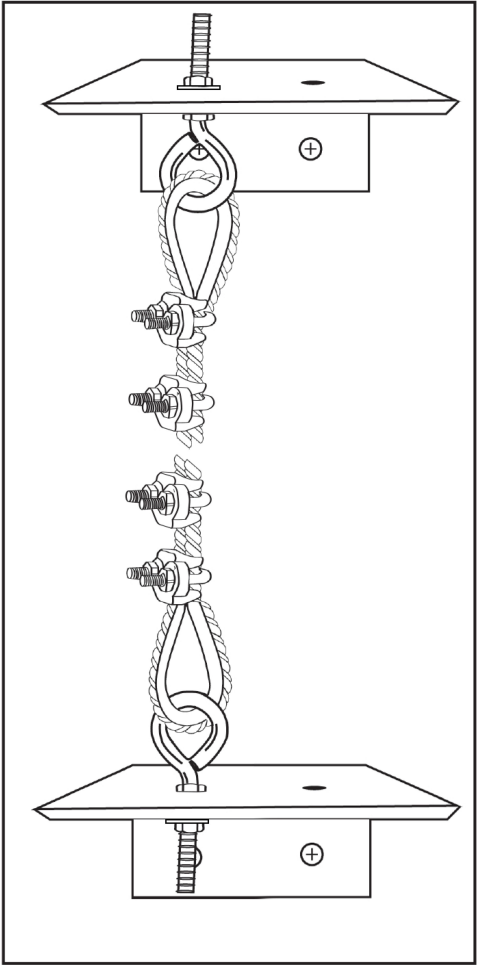
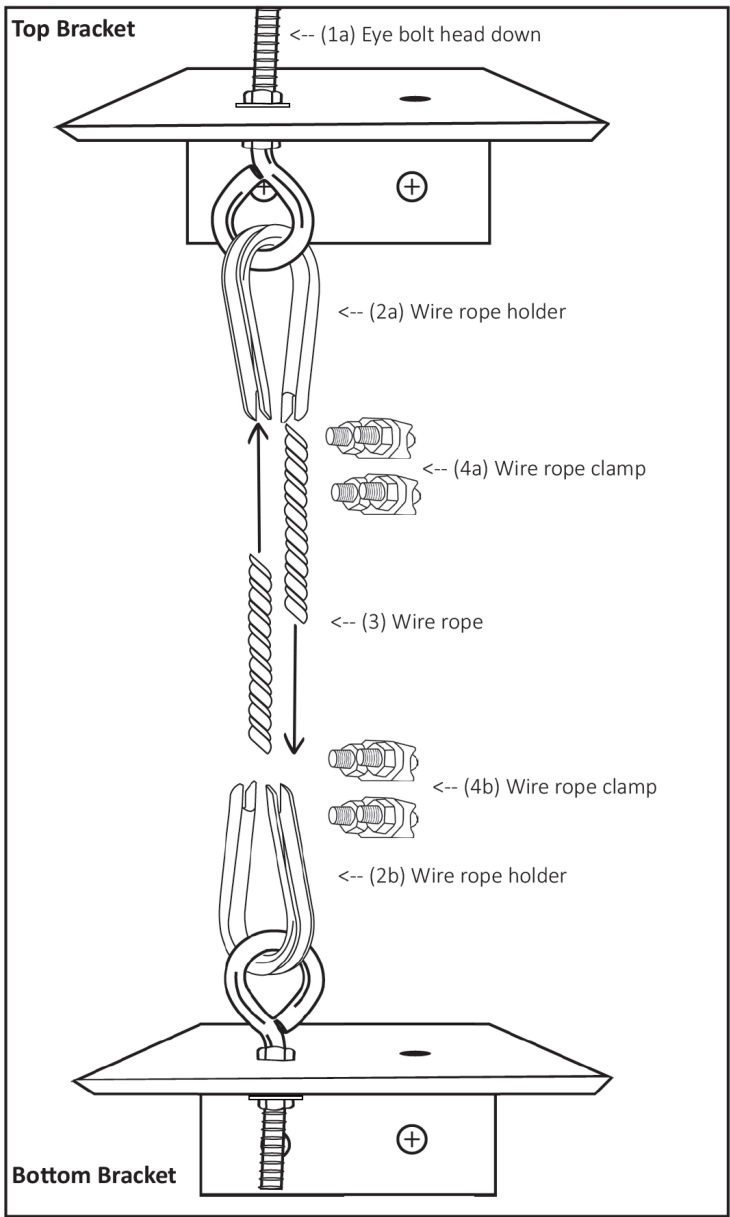

PREVENT CTFS INSTRUCTIONS

Pulley and Ratchet Installation

Parts: (2) Poly Braid Rope Bundles; (2) Rope Ratchets with Hooks; (2) Single Eye Pulleys with Eye Bolts; (4) Hex Nuts; (4) Washers; (2) Eye Bolts.

Note: Poly braid rope must be preassembled to the rope ratchets with hooks. Thread rope through the ratchet:

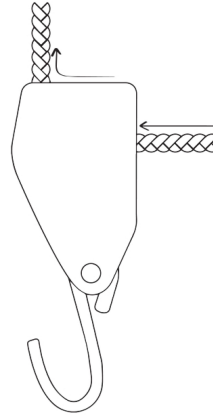

Assembly:

Eye Pully

- Eye Bolts are pre-attached to 2 Eye Pulleys. Attach those Eye Bolts to the inside holes of the fixed Brackets on each corner. The Eye Bolts on the Top Bracket must be head down, and on the Bottom Bracket - Eye Bolts must be head up. Use Hex Nuts and washers, above and below bracket for stability.

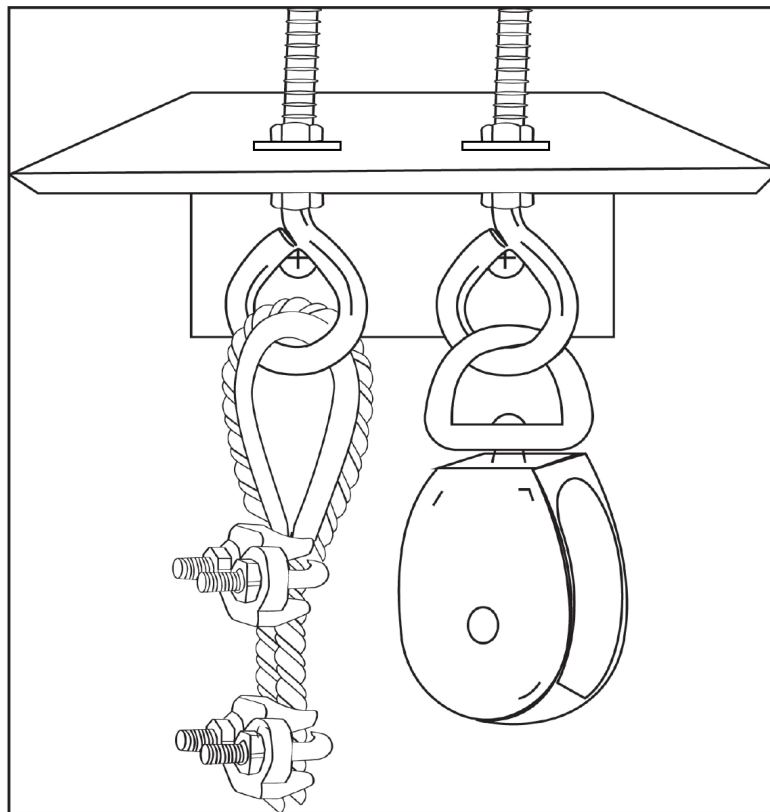

PREVENT CTFS INSTRUCTIONS

- Thread your rope (that's already preassembled to the ratchet) through the single eye pulley and let it hang to the ground on both sides.
- Attach the preassembled ratchet with hook to the bottom inside eyebolt.

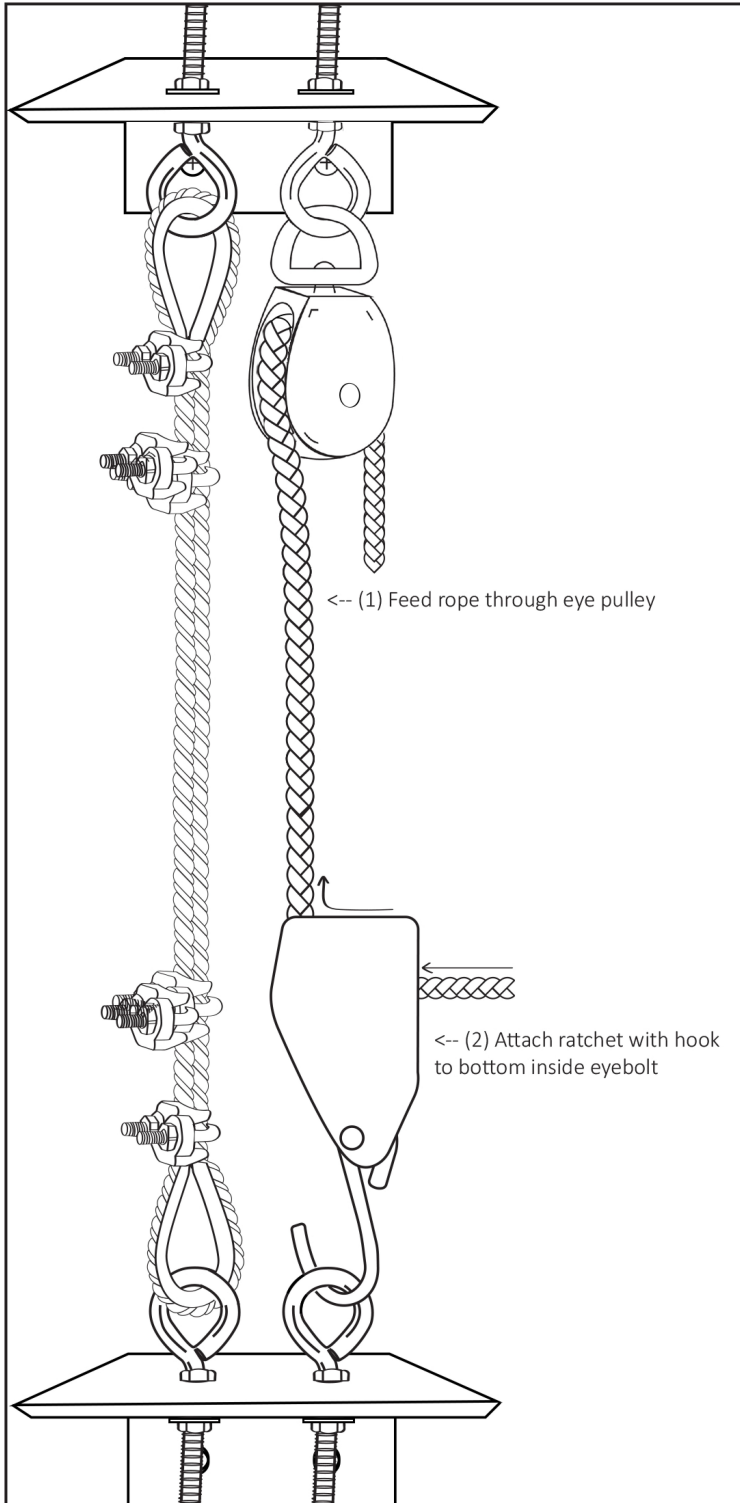

Rope Ratchet with Hooks

- Attach the rope ratchet hook through the inside Eye Bolt on each bottom bracket.
- Easily adjust tension of the filter screen once it is raised.

PREVENT CTFS INSTRUCTIONS

Side Guide Installation

Parts: Carabiner clips - for wire rope side guides, quantity based on the number of grommets ordered.

Note: Attach the carabiner clips through the grommets in advance and feed your rope through before raising the filter screen OR add the clips as you raise it. Each carabiner must clip around the Wire Guide Rope on each side to provide stability to the installation.

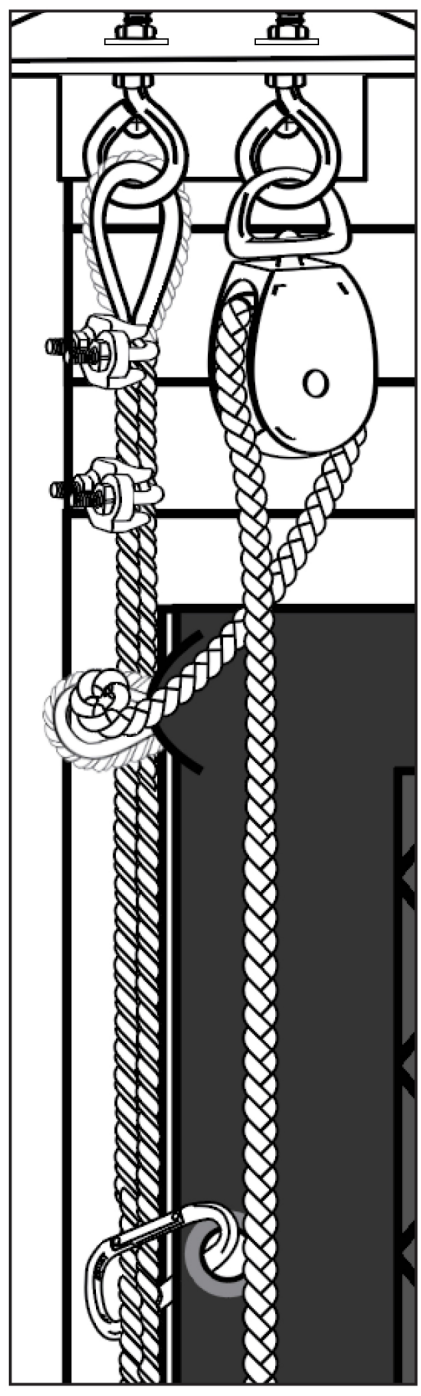
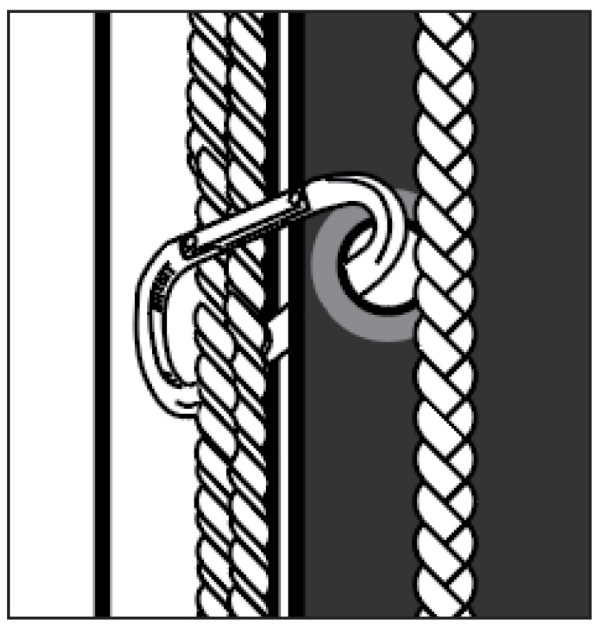

PreVent Cooling Tower Filter System By Permatron Corporation

